

S/M No. : FR490P0010

DAEWOO

Service Manual

Refrigerator

Model: FR-490M
FR-490P



DAEWOO ELECTRONICS CO., LTD.

1. Specification -----	1
2. External view -----	2
3. Wire diagram -----	3
4. Name of parts-----	4
5. Air flow diagram-----	5
6. Refrigerant cycle diagram -----	6
7. Machine room view and part list-----	7
8. Main components-----	8
9. Door color specification-----	11
10. Exploded view and parts list -----	16
11. Electronic function -----	20

1. SPECIFICATION

MODEL NAME		FR-490M	FR-490P
Refrigerant	R12	180g	180g
	R134a	150g	150g
Cooling System		Fan Cooling Convection	
Refrigeration System		Air Forced Convection	
Defrost System		Fin Evaporator Forced	
Defrost Operation		Automatic Start & Stop	
Cold Control		Adjustable Dial	Adjustable Button
Capacity	Freezer	111 ℓ	111 ℓ
	Refrigerator	299 ℓ	299 ℓ
	Total	410 ℓ	410 ℓ
External Dimension	Height	1771mm	1771mm
	Width	750mm	750mm
	Depth	642mm	642mm
Net Weight		76Kg	76Kg

2. EXTERNAL VIEW

1. FR-490M

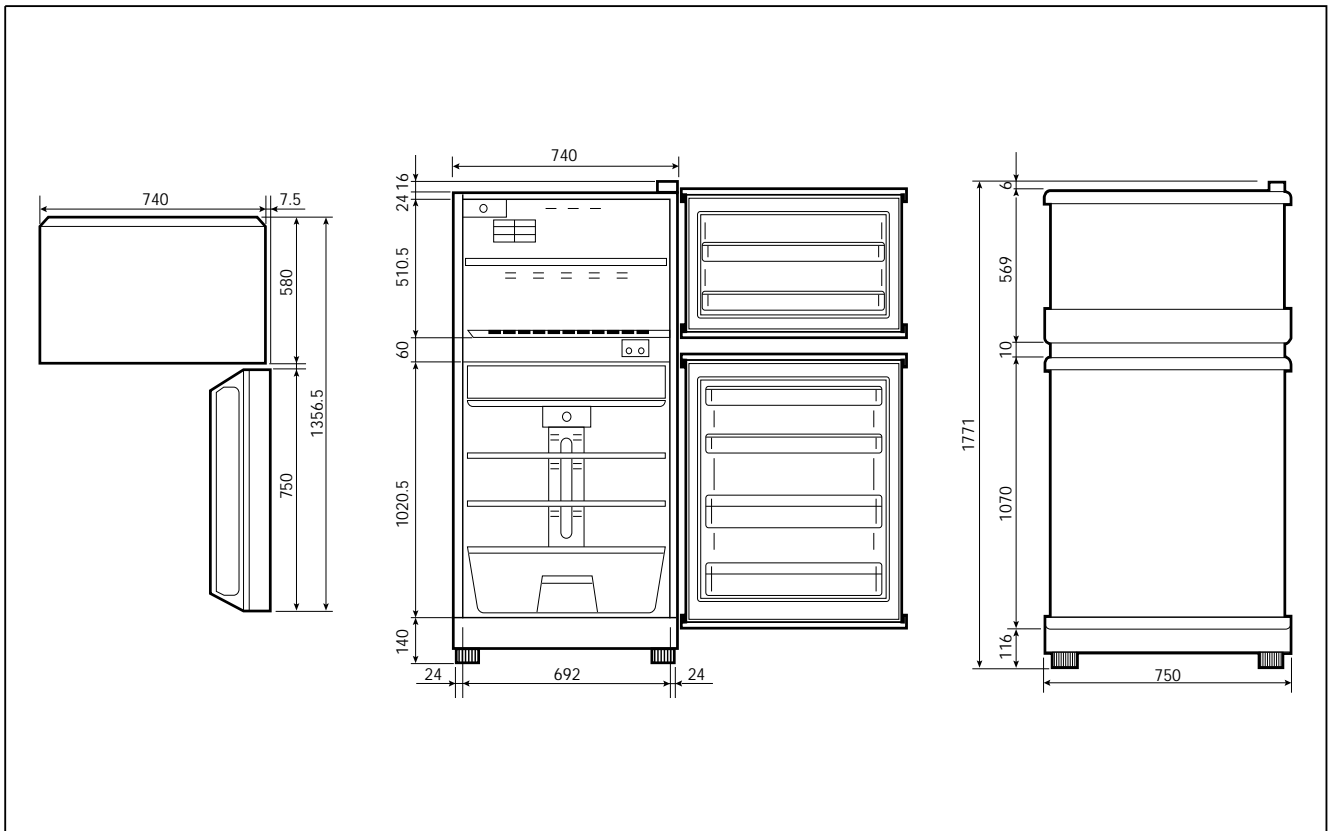

2. FR-490P

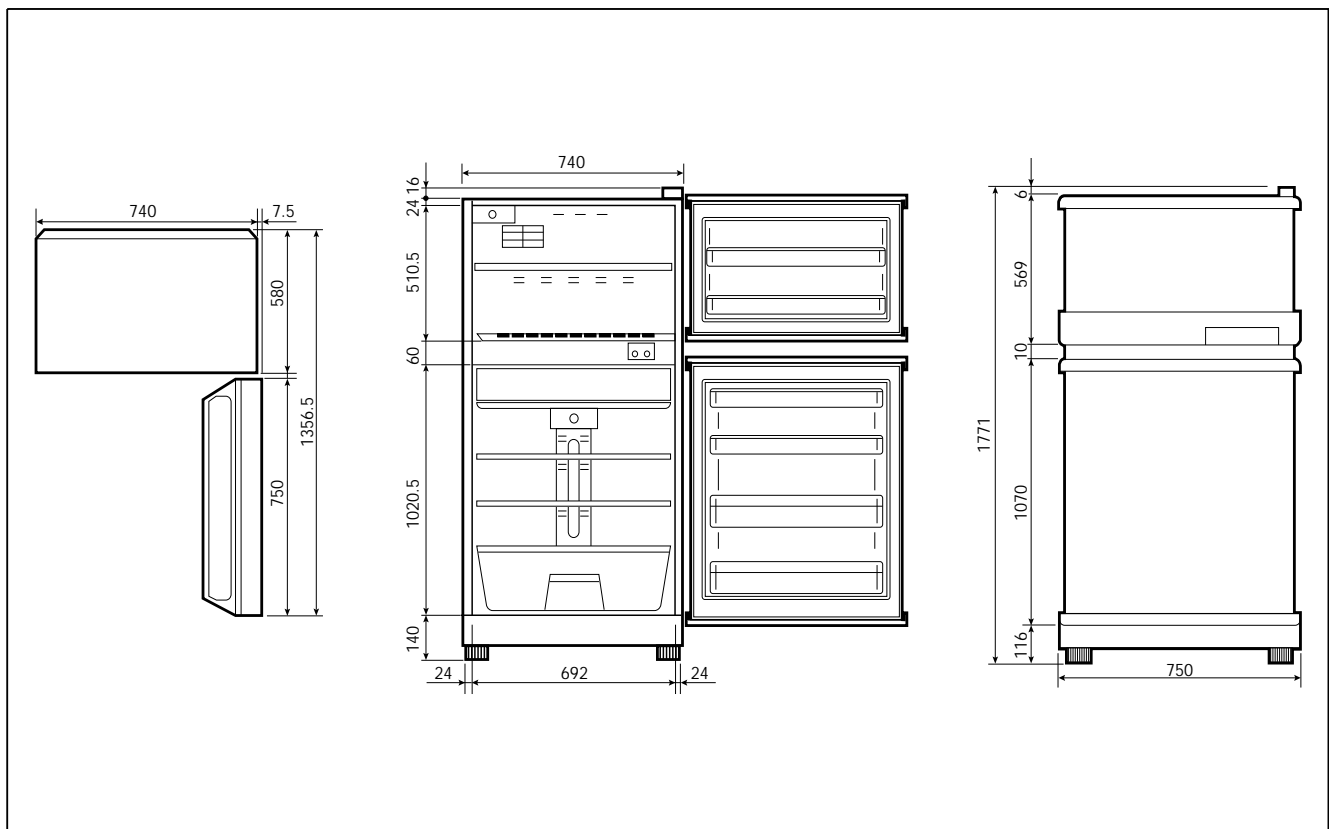

3. WIRE DIAGRAM

1. FR-490M

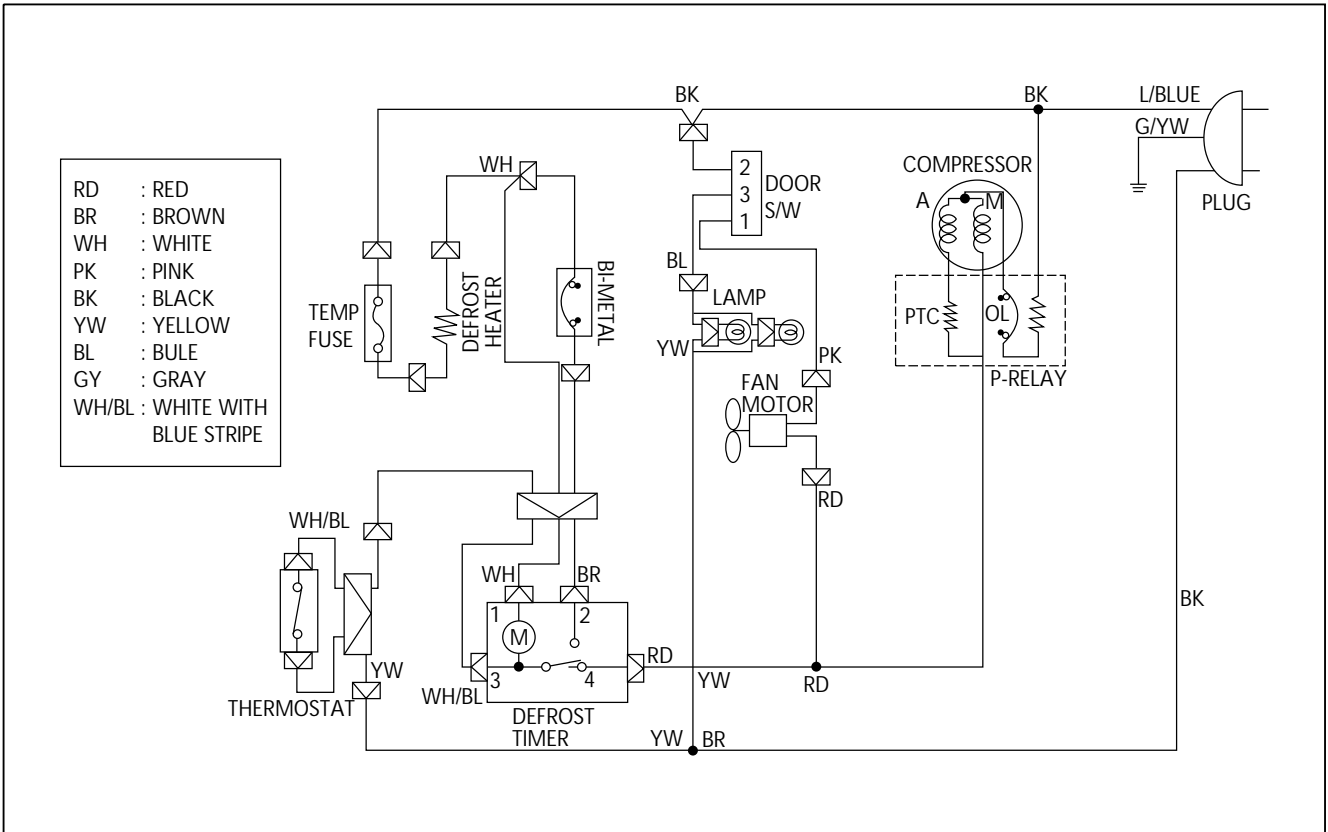

2. FR-490P

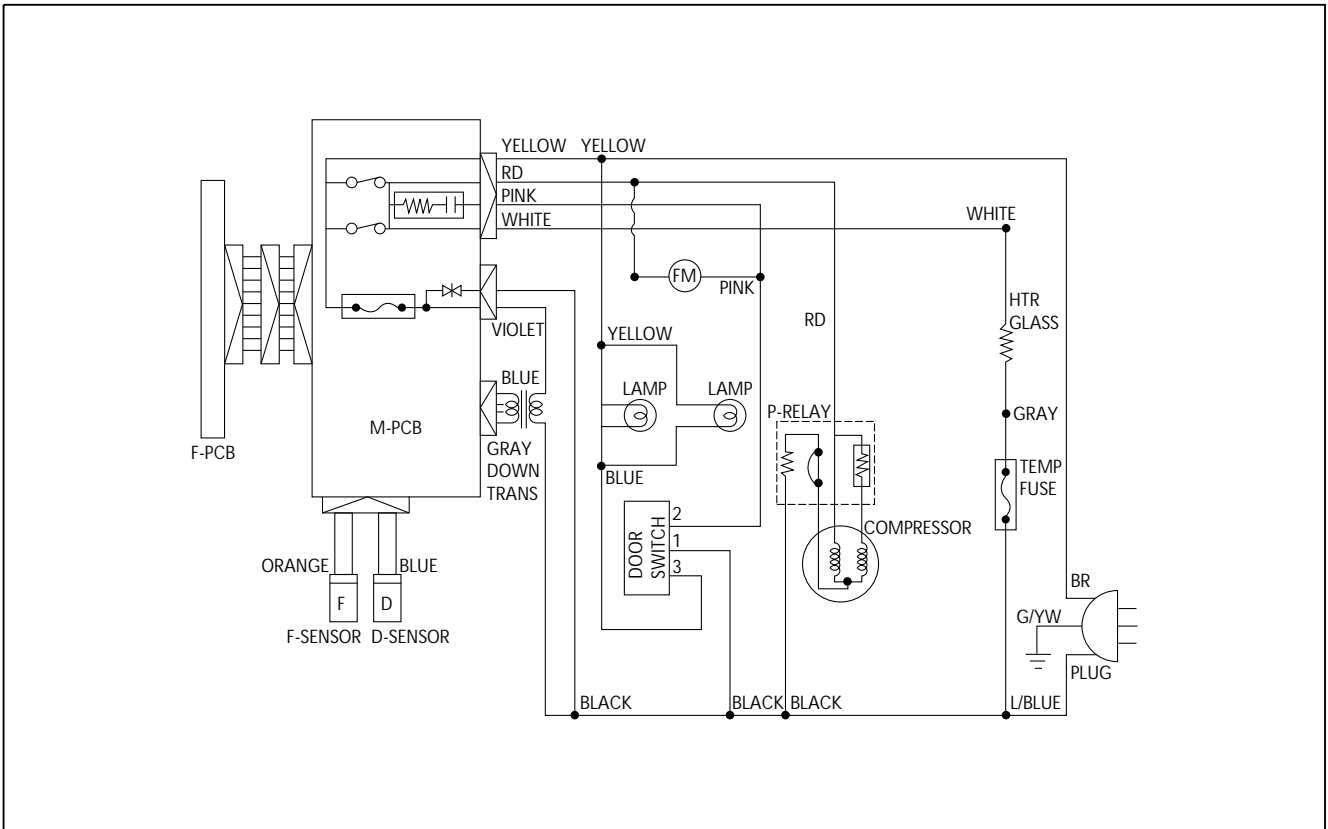

4. NAME OF PARTS

1. FR-490M

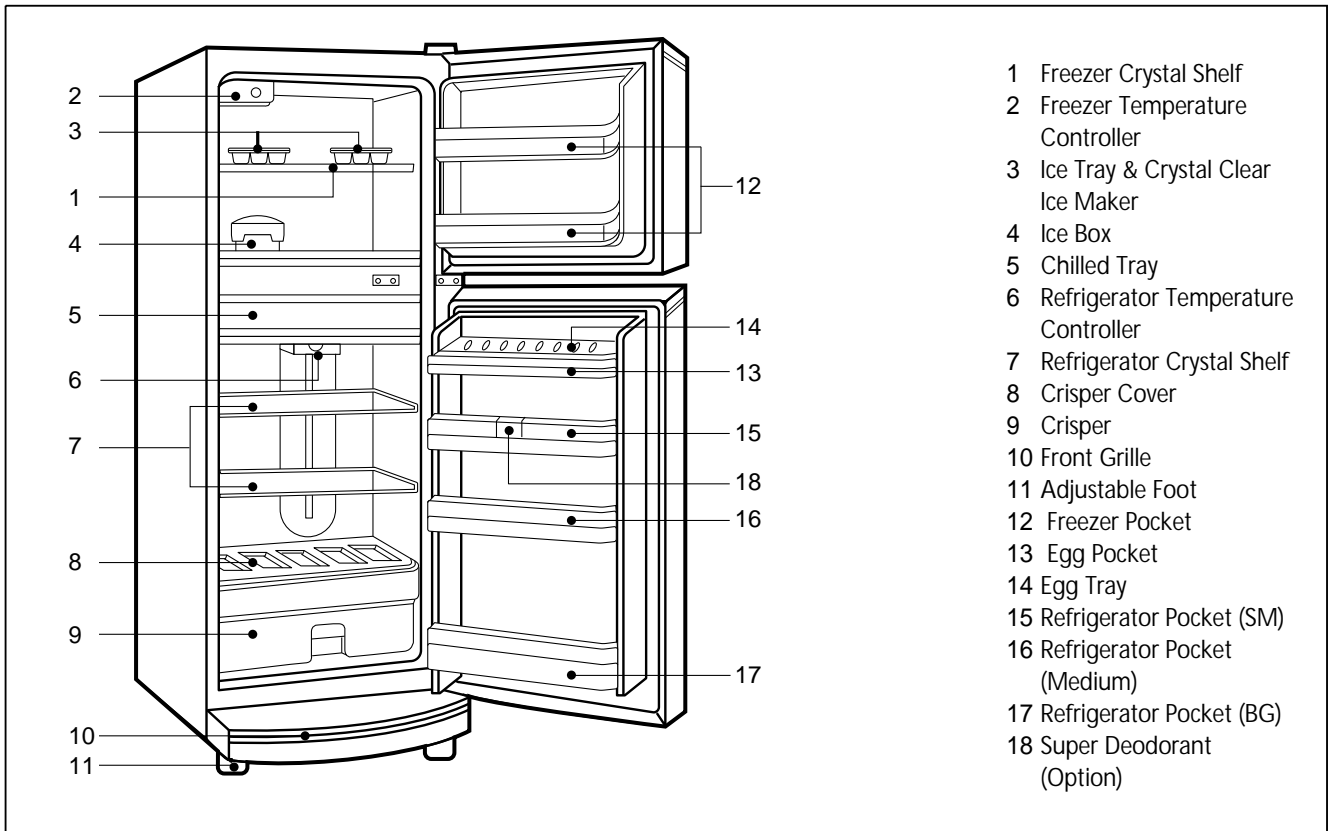

2. FR-490P

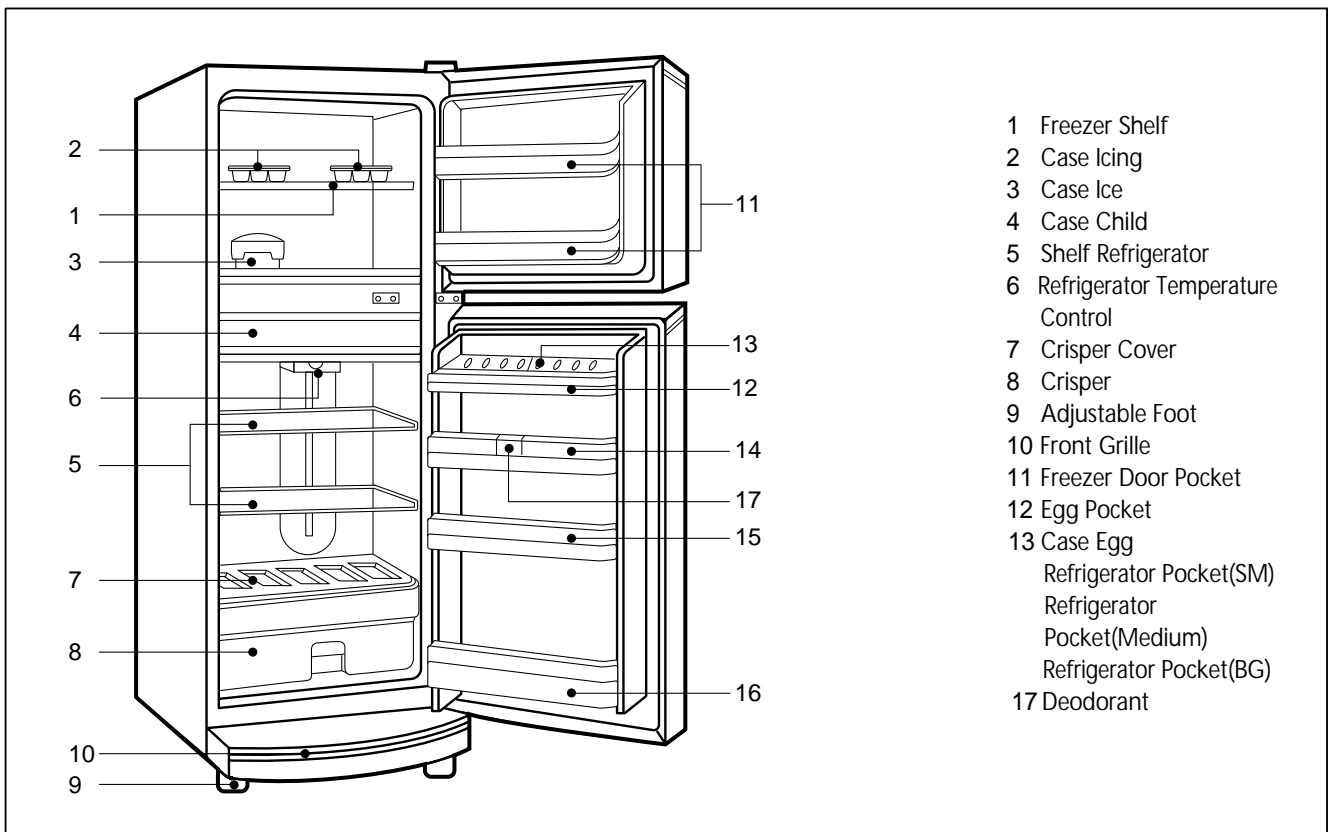

5. AIR FLOW DIAGRAM

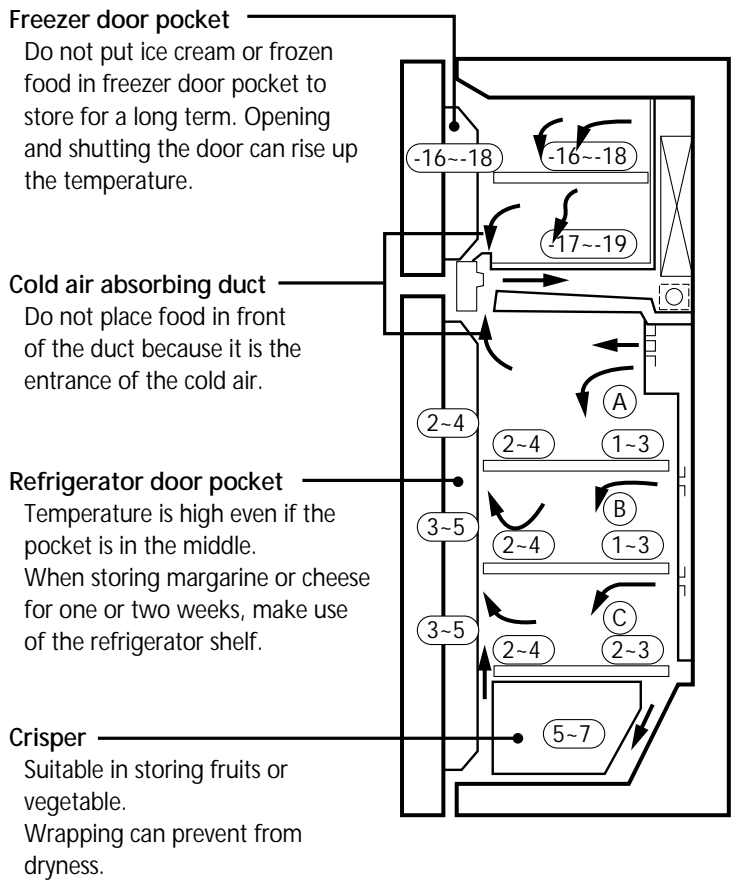

Freezer door pocket
Do not put ice cream or frozen food in freezer door pocket to store for a long term. Opening and shutting the door can rise up the temperature.

Cold air absorbing duct
Do not place food in front of the duct because it is the entrance of the cold air.

Refrigerator door pocket
Temperature is high even if the pocket is in the middle. When storing margarine or cheese for one or two weeks, make use of the refrigerator shelf.

Crisper
Suitable in storing fruits or vegetable. Wrapping can prevent from dryness.

Freezer room
Do not put any bottle such as beer or beverage because it can be frozen and broken.

Refrigerating room
This model is multi-flow type which flows out cold air from each shelf space. The hot air after making the refrigerator cold, flows into cooling system through the front upper part.

Do not put food having much moisture at the middle part of each shelf space ("A", "B" and "C" part). It can be frozen owing to the low temperature.

6. REFRIGERANT CYCLE DIAGRAM

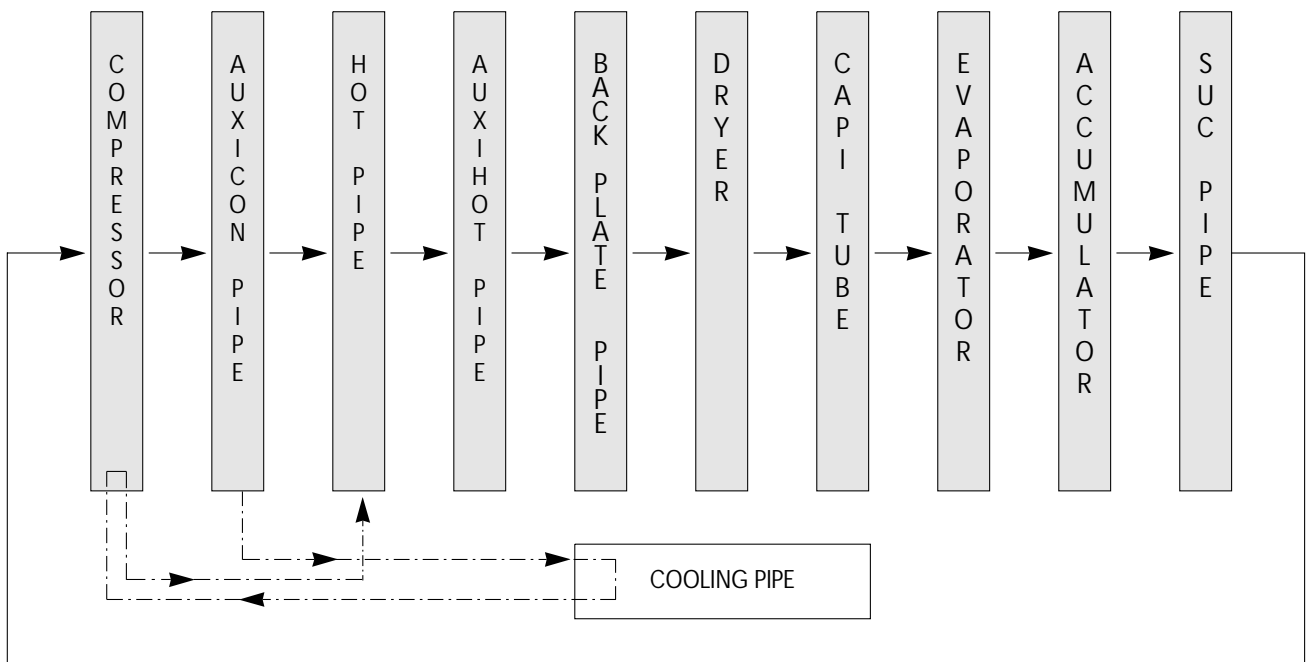
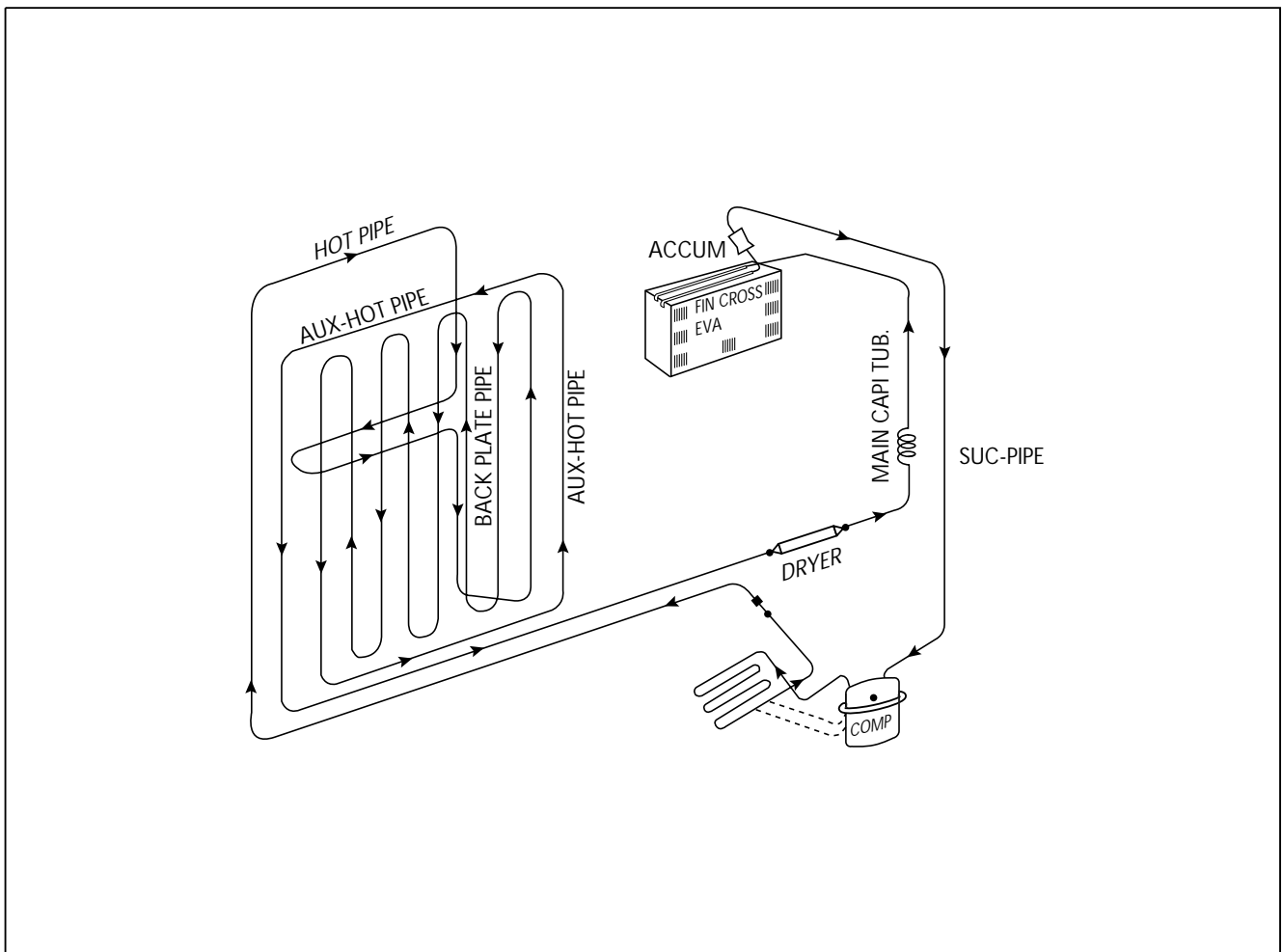

7. MACHINE ROOM VIEW AND PART LIST

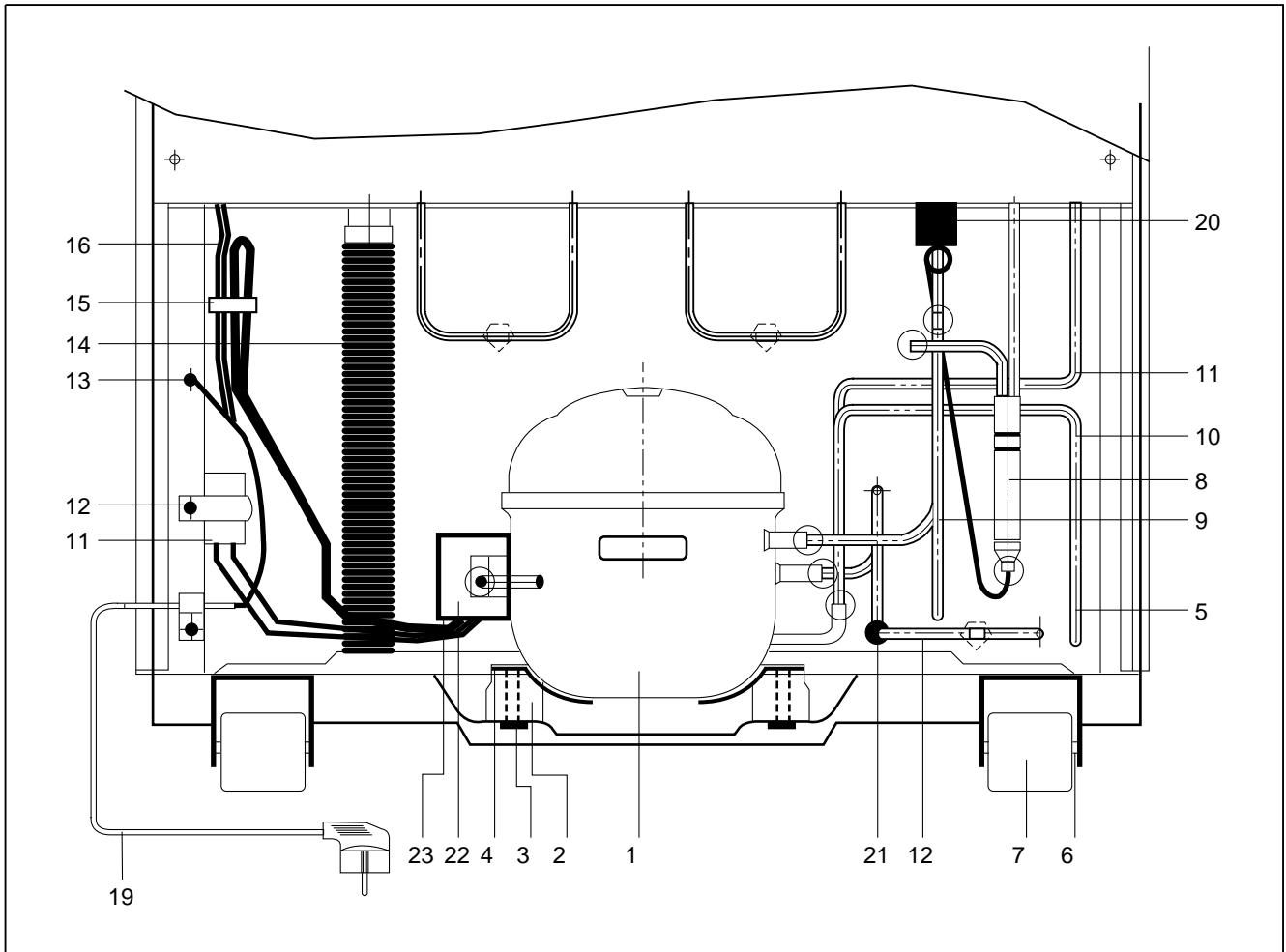

NO	PART NAME	NO	PART NAME	NO	PART NAME
1	COMPRESSOR	9	PIPE CON (SUC)	17	CABLE CLAMP
2	ABSORBER	10	PIPE COOLING CON (AUX)	18	STARTING CAPACITOR
3	BOLT COMP. FIXTURE	11	PIPE COOLING (A)	19	POWER CORD
4	FIXTURE COMP. WASHER	12	PIPE CON (P.A)	20	ABSORBER PIPE
5	PLATE AUX-CON AS	13	SCREW MACHINE	21	VIBRATIONPROOF MASS(B)
6	CASTER PIN	14	DRAIN HOSE(B) AS	22	SWITCH P-RELAY AS
7	CASTER	15	TAPE OPP	23	RELAY BAND
8	DRYER	16	CEC COVER		

8. MAIN COMPONENTS

1. COMPRESSOR

Refrigerant	R12							
Voltage	100V/50,60Hz	110V/60Hz	115, 120V/60Hz	127V/60Hz	220V/50Hz	220V/60Hz	230V/50Hz	240V/50Hz
Comp. model	X	CL27YE-3-C	CL27YE-1-C	CL27YE-2-C	SL28YE-4E-C	KL27YE-4E-C	PL25YE-4	SL28YE-6-C
Part code	X	3957127C30	3957127C10	3957127C20	3954128C60	3958127C60	3956125442	3956128C60
Strating type	X	CSIR	CSIR	SCIR	RSIR	CSIR	RSCR	RSIR

Refrigerant	R134a							
Voltage	100V/50,60Hz	110V/60Hz	115, 120V/60Hz	127V/60Hz	220V/50Hz	220V/60Hz	230V/50Hz	240V/50Hz
Comp. model	X	HBL27YE-3-C	HBL27YE-1-C	X	HSL27YE-5-C	X	HSL27YE-5-C	←
Part code	X	3952127L30	3952127L10	X	3954127L50	X	3954127L50	←
Strating type	X	CSR	CSR	X	RSIR	X	RSIR	←

2. RELAY ASSEMBLY

Refrigerant	R12							
Voltage	100V/50,60Hz	110V/60Hz	115, 120V/60Hz	127V/60Hz	220V/50Hz	220V/60Hz	230V/50Hz	240V/50Hz
Relay model	X	444UHBZZ-52	←	437THBYY-52	276THBYY-52	730RFBYY-52	197SHBYY-52	213THBYY-52
Part code	X	3018105720	←	3018109530	3018105031	3018105021	3018109700	3018105061

Refrigerant	R134a							
Voltage	100V/50,60Hz	110V/60Hz	115, 120V/60Hz	127V/60Hz	220V/50Hz	220V/60Hz	230V/50Hz	240V/50Hz
Relay model	X	783SHBZZ-52	←	X	276THBYY-52	X	276THBYY-52	←
Part code	X	3018105720	←	X	3018105031	X	3018109510	3018105031

3. RUNNING CAPACITOR

Refrigerant	R12							
Voltage	100V/50,60Hz	110V/60Hz	115, 120V/60Hz	127V/60Hz	220V/50Hz	220V/60Hz	230V/50Hz	240V/50Hz
Spec.	X	X	X	X	X	300V/5μF	X	350V/5μF
Part code	X	X	X	X	X		X	400EL15110

Refrigerant	R134a							
Voltage	100V/50,60Hz	110V/60Hz	115, 120V/60Hz	127V/60Hz	220V/50Hz	220V/60Hz	230V/50Hz	240V/50Hz
Spec.	X	230V/10μF	←	X	X	X	X	X
Part code	X	400EL15130	←	X	X	X	X	X

4. STARTING CAPACITOR

Refrigerant	R12							
Voltage	100V/50,60Hz	110V/60Hz	115, 120V/60Hz	127V/60Hz	220V/50Hz	220V/60Hz	230V/50Hz	240V/50Hz
Spec.	X	140V/100μF	←	←	X	350V/25μF	X	X
Part code	X		←	←	X	400EL16110	X	X

Refrigerant	R134a							
Voltage	100V/50,60Hz	110V/60Hz	115, 120V/60Hz	127V/60Hz	220V/50Hz	220V/60Hz	230V/50Hz	240V/50Hz
Spec.	X	200V/100μF	←	X	X	X	290V/50μF	X
Part code	X	3016400100	←	X	X	X	4124G62020	X

5. F-FAN MOTOR

Refrigerant	R12, R134a							
Voltage	100V/50,60Hz	110V/60Hz	115, 120V/60Hz	127V/60Hz	220V/50Hz	220V/60Hz	230V/50Hz	240V/50Hz
Spec.	X	3210DWNFH-2	←	←	3210DWNFF-2	3210DWNFD-1	3210DWNFI-1	←
Part code	X	401VB42021	←	←	401VA42021	4017G24502	401UB42021	←

6. DEFROST HEATER

Refrigerant	R12, R134a							
Voltage	100V/50,60Hz	110V/60Hz	115, 120V/60Hz	127V/60Hz	220V/50Hz	220V/60Hz	230V/50Hz	240V/50Hz
Spec.	X	148W	←	←	148W	←	←	←
Part code	X	400EL22311	←	←	400EL22211	←	←	←

7. LAMP ASSEMBLY

Refrigerant	R12, R134a							
Voltage	100V/50,60Hz	110V/60Hz	115, 120V/60Hz	127V/60Hz	220V/50Hz	220V/60Hz	230V/50Hz	240V/50Hz
Spec.	X	10W	←	←	13W	←	←	←
Part code	X	4019S15200	←	←	400EL20111	←	←	←

8. DEFROST TIMER (FR-490M)

Refrigerant	R12, R134a							
Voltage	100V/50,60Hz	110V/60Hz	115, 120V/60Hz	127V/60Hz	220V/50Hz	220V/60Hz	230V/50Hz	240V/50Hz
Spec.	X	TMDEX09UA1	←	←	TMDEX09UC1	←	←	←
Part code	X	3018101200	←	←	3018100300	←	←	←

9. PCB TRANSFORMER (FR-490P)

Refrigerant	R12, R134a							
Voltage	100V/50,60Hz	110V/60Hz	115, 120V/60Hz	127V/60Hz	220V/50Hz	220V/60Hz	230V/50Hz	240V/50Hz
Part code	X	5EPK060606	←	←	5EPK060508	←	5EPK060080	5EPK060509

10. MAIN PCB ASSEMBLY (FR-490P)

Refrigerant	R12, R134a							
Voltage	100V/50,60Hz	110V/60Hz	115, 120V/60Hz	127V/60Hz	220V/50Hz	220V/60Hz	230V/50Hz	240V/50Hz
Spec.	X	P706	←	←	←	←	←	←
Part code	X	3014300830	←	←	3014300530	←	←	←

11. DRYER

Refrigerant	R12	R134a
Spec.	10 g	15 g
Part code	3016800103	3016801100

POWER CORD SPECIFICATION

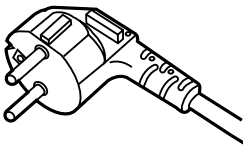
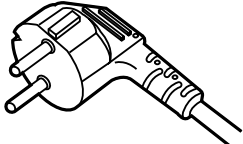
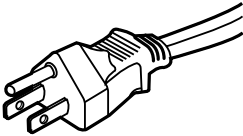
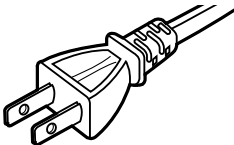
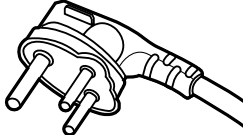
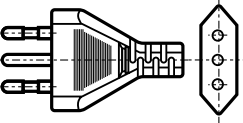
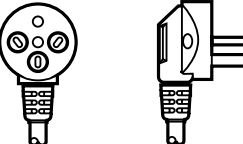
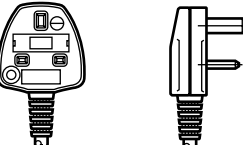
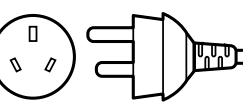
NO	SHAPE OF POWER CODE	PART CODE	DESCRIPTION	REMARK
1		3011315000	CP-2PIN	FOR EUROPEAN COUNTRY
2		401RA17200	CP-2PIN	FOR OTHER COUNTRY
3		4006D17101	KP-30	FOR AMERICA
4		401PD17101	KP-211	FOR JAPAN & TAIWAN
5		3011300801	BP-3PIN	
6		3011303010	#267	FOR CHILE
7		3011315310		FOR ISRAEL
8		3011303050	BS-1363A	FOR U.K, MIDDLE ASIA SINGAPORE & MALAYSIA
9		3011301200	KP-551/550	FOR CHINA & AUSTRALIA

* Upper power cord's part code is only for lead wire, without any kinds of terminal or housing.

9. DOOR COLOR SPECIFICATION

1. ASSEMBLY URETHAN FREEZER DOOR

1) FR-490M

Refrigerant	R12				R134a			
	Dull lamina sheet	High glossy lamina sheet	Normal PCM	High glossy bright PCM	Dull lamina sheet	High glossy lamina sheet	Normal PCM	High glossy bright PCM
Part code	X	PFDT1UF090	X	X	X	PFDT1UJ095	X	X

2) FR-490P



Refrigerant	R12				R134a			
	Dull lamina sheet	High glossy lamina sheet	Normal PCM	High glossy bright PCM	Dull lamina sheet	High glossy lamina sheet	Normal PCM	High glossy bright PCM
Part code	X	PFDT1UJ170	X	X	X	PFDT1UJ175	X	X

2. ASSEMBLY URETHAN REFRIGERATOR DOOR

Refrigerant	R12				R134a			
	Dull lamina sheet	High glossy lamina sheet	Normal PCM	High glossy bright PCM	Dull lamina sheet	High glossy lamina sheet	Normal PCM	High glossy bright PCM
Part code	X	PFDY2UJ170	X	X	X	PFDY2UJ175	X	X

COLOR TABLE

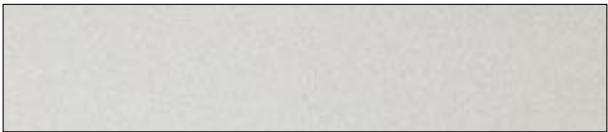
1. PCM type

NO	COLOR CHIP	COLOR NAME
1		P/WITH (WH069)
2		'94 L/GRAY (GY158)
3		'95 L/GRAY (GY259)
4		'94 M/GRAY (GY331)
5		'95 M/GRAY (GY335)
6		'97 M/GRAY (GY267)
7		M. D/GRAY (GY750)
8		N/BLUE (BL718)
9		MINT GREEN (GN206)
10		'97 BEIGE (BE215)

2. Lamina sheet type

NO	COLOR CHIP	COLOR NAME
1		P/WITH (WH069)
2		'94 L/GRAY (GY158)
3		'95 L/GRAY (GY259)
4		'94 M/GRAY (GY331)
5		'95 M/GRAY (GY335)
6		'97 M/GRAY (GY267)
7		M. D/GRAY (GY750)
8		N/BLUE (BL718)
9		MINT GREEN (GN206)
10		S/GOLD
11		G/GREEN

10. EXPLODED VIEW AND PARTS LIST

1. FR-490M

1. Exploded view

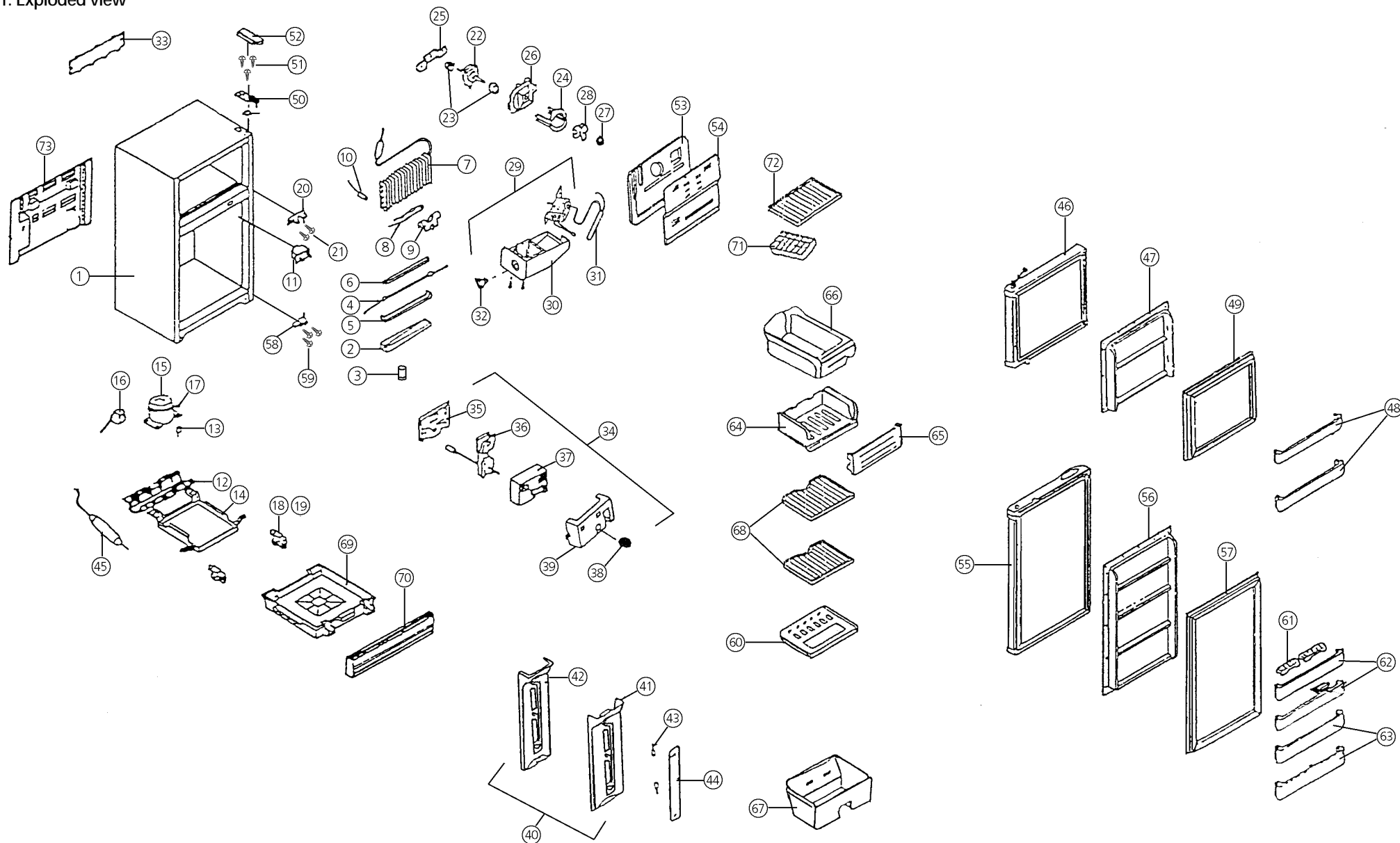

2. Parts list

NO	PART CODE	PART NAME	DESCRIPTION	QUANTITY	REMARK
1		ASSY URT CAB		1	
2	4010G54111	GUIDE DRN	AL	1	
3	4018G54120	PIPE DRN	AL T1.0	1	
4		HTR GLASS TUBE AS		1	REFER TO # 9
5	4017Z73580	COVER DEFR HTR *U	AL	1	
6	4017Z73570	COVER DEFR HTR *T	AL	1	
7	3017044700	EVAPORATOR FIN AS		1	
8	400EL21213	FUSE TEMP AS		1	
9	4017Z90590	FIXTURE FUSE TEMP	PP	1	
10	3018111100	SWITCH BIMTL AS		1	
11	3010023400	SWITCH DR AS		1	
12	3010300602	BASE COMP	T1.2	1	
13	3010100201	ABSORBER COMP	NR H=40	4	
14	3014500403	PLATE AXCON AS	SGCC	1	
15		COMPRESSOR		1	REFER TO # 8
16		SWITCH P RELAY AS		1	REFER TO # 8
17	4019H09030	SPECIAL WASHER	SWRH	4	
18	4017Z40622	FOOT *F ASS		2	
19	4017Z40192	ADJ FOOT AS	PP	2	
20	4012900630	HINGE *M AS	ZN DC-2	1	
21	3016000220	SPECIAL SCREW	M6X16 SWCH22A	2	
22		MOTOR SHADED AS		1	REFER TO # 9
23	4017Z08430	ABSORBER MOTR	EPR-B3 (H40)	1	
24	4017Z86412	FAN MOTOR COVR (A)	HIPS	1	
25	4017Z32244	COVER MOTR B	HIPS	1	
26	4017Z32233	COVER MOTR C	HIPS	1	
27	4004Q10060	FIXTURE FAN	STS	1	
28	4017Z42312	FAN	ABS	1	
29	3010501601	BOX CONTL AS		1	
30	3010500403	BOX CONTL	HIPS	1	
31	3018300401	THERMOSTAT		1	
32	4017G31041	KNOB C/S	ABS	1	
33	4010G90133	M-PCB COVER		1	
34	4010G26003	ASSY R-DAMPR		1	
35	4010G26030	INSULATOR DAMP B	F-PS	1	
36	4010G26400	DAMPER		1	
37	4010G26022	INSULATOR DAMP A	F-PS	1	
38	4017G31152	KNOB DAMP	ABS	1	
39	4010G26016	COVER DAMP	HIPS	1	

NO	PART CODE	PART NAME	DESCRIPTION	QUANTITY	REMARK
40	401SD75302	MULTI DUCT AS		1	
41	4010G75215	DUCT MULTI	HIPS	1	
42	4010G75253	INSULATOR M/F DUCT	F-PS	1	
43		LAMP AS		2	REFER TO # 9
44	4010G15311	SHADE R	GPS	1	
45		DRYER AS		1	REFER TO # 9
46		ASSY URT *T DOOR		1	RFEER TO # 11
47	4010G46014	LINER F DR	ABS 1.4X785X1200	1	
48	4010G30090	POCKET F *T	GPS	2	
49	4010G47104	GASKET F DR	PVC-S 42	1	
50	4010G51402	HINGE *T AS	SPHC	1	
51	3016000301	SPECIAL SCREW	M5X14 S1018C ZN5MICRO	3	
52	4010G51455	COVER *T HI	PP 42	1	
53	4010G74202	LOUVER F INSU AS		1	
54	4010G74012	LOUVER F	HIPS	1	
55		ASSY URT *U DOOR		1	REFER TO # 11
56	4010G37017	LINER R DR	ABS 1.4X785X1105	1	
57	4010G47204	GASKET R DR AS		1	
58	3012900401	HINGE *U AS	MF-ZN5-C	1	
59	3016000600	SPECIAL SCREW	M6X20	4	
60	30100A0271	COVER V/CASE AS		1	
61	4010G30621	CASE EGG	GPS	2	
62	4010G30611	POCKET EGG	HIPS	2	
63	4010G30640	POCKET BOTL	HIPS	2	
64	3011108900	CASE CHILD	GPS	1	
65	3011715600	DOOR CHILD	GPS	1	
66	4010E99102	BOX ICE AS		1	
67	3011424100	CASE VEGETB	GPS	1	
68	4010G55120	SHELF R	GP	2	
69	4010G30661	BOILD	PP T1.3	1	
70	4010G65015	COVER CAB BRKT	PP	1	
71	3011100400	CASE ICING AS		1	
72	3017808200	SHELF F	GPS (INSAE=MU)	1	
73	4010G00018	GRILLE	PP(B-391G YUKONG)	1	
74	4010E59900	DEODORANT		1	OPTION

2. FR-490P

1. Exploded view

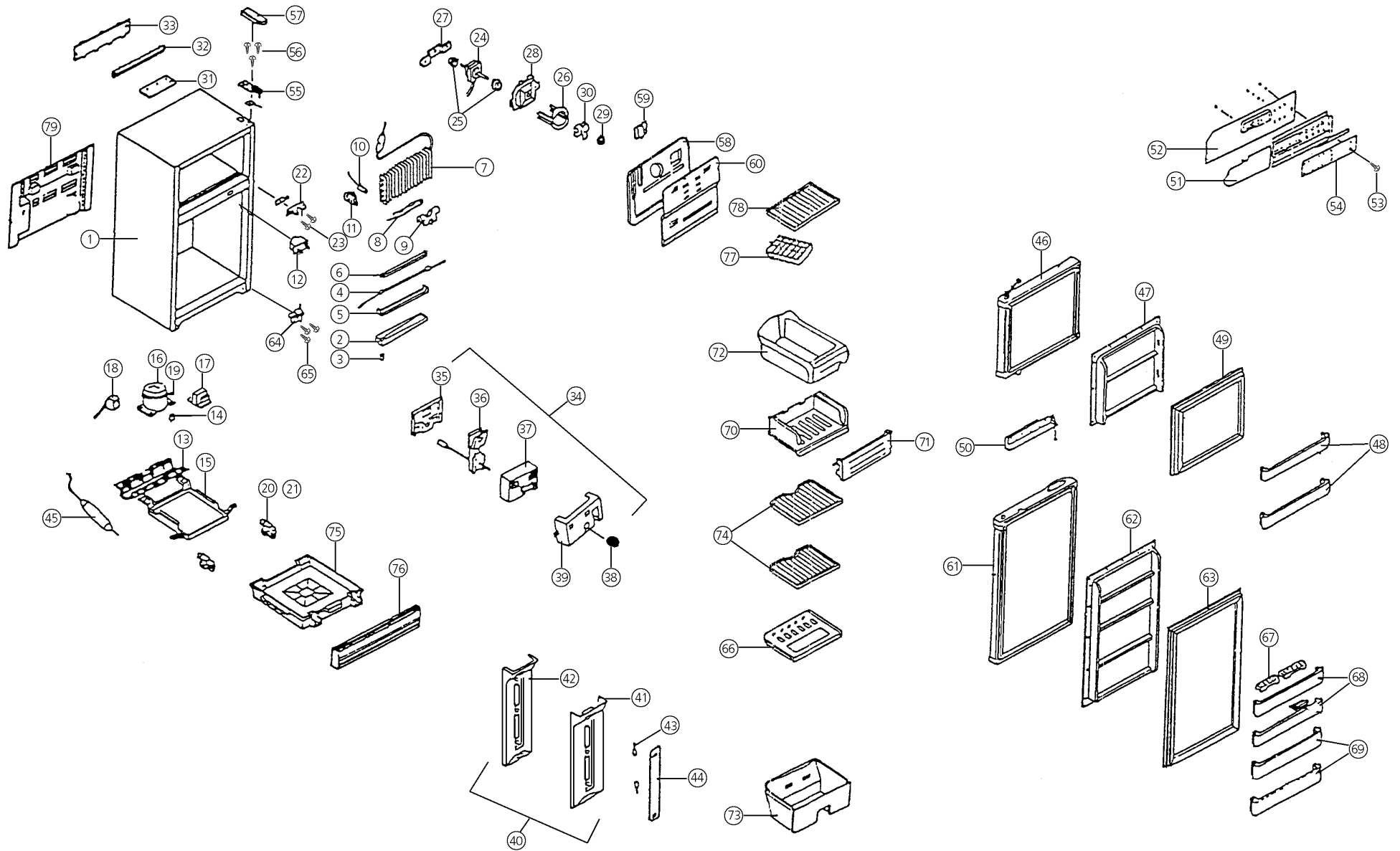

2. Parts list

NO	PART CODE	PART NAME	DESCRIPTION	QUANTITY	REMARK
1		ASSY URT CAB		1	
2	4010G54111	GUIDE DRN	AL	1	
3	4018G54120	PIPE DRN	AL T1.0	1	
4		HTR GLASS TUBE AS		1	REFER TO # 64
5	4017Z73580	COVER DEFR HRT *U	AL	1	
6	4017Z73570	COVER DEFR HTR *T	AL	1	
7	3017044700	EVAPORATOR FIN AS		1	
8	400EL21213	FUSE TEMP AS		1	
9	4017Z90590	FIXTURE FUSE TEMP	PP	1	
10	400EL30141	SENSOR TEMP AS	FD10	1	
11	3012001102	FIXTURE TEMP SENS	PP	1	
12	3010023400	SWITCH DR AS		1	
13	3010300602	BASE COMP	T1.2	1	
14	3010100201	ABSORBER COMP	NR H=40	4	
15	3014500403	PLATE AXCON AS	SGCC	1	
16		COMPRESSOR		1	REFER TO # 8
17		TRANS POWER		1	REFER TO # 9
18		SWITCH P RELAY AS		1	REFER TO # 8
19	4019H09030	SPECIAL WASHER	SWRH	4	
20	4017Z40622	FOOT *F ASS		2	
21	4017Z40192	ADJ FOOT AS	PP	2	
22	3012900630	HINGE *M AS	ZN DC-2	1	
23	3016000220	SPECIAL SCREW	M6x16 SWCH 22A	2	
24		MOTOR SHADED AS		1	REFER TO # 9
25	4017Z08430	ABSORBER MOTR	EPR-B3(H40)	1	
26	4017Z86412	FAN MOTOR COVER(A)	HIPS	1	
27	4017Z32244	COVER MOTR B	HIPS	1	
28	4017Z32233	COVER MOTR C	HIPS	1	
29	4004Q10060	FIXTURE FAN	STS	1	
30	4017Z42312	FAN	ABS	1	
31		PCB MAIN AS		1	REFER TO # 64
32	4019R28472	FIXTURE M/PCB	PP	1	
33	4010G90133	PCB-M COVR	PP	1	
34	4010G26003	ASSY R-DAMPR		1	
35	4010G26030	INSULATOR DAMP B	F-PS	1	
36	4010G26400	DAMPER		1	
37	4010G26022	INSULATOR DAMP A	F-PS	1	
38	4017G31152	KNOB DAMP	ABS	1	
39	4010G26016	COVER DAMP	HIPS	1	

NO	PART CODE	PART NAME	DESCRIPTION	QUANTITY	REMARK
40	401SD75302	MULTI DUCT AS		1	
41	4010G75215	DUCT MULTI	HIPS	1	
42	4010G75253	INSULATOR M/F DUCT	F-PS	1	
43		LAMP AS		2	REFER TO # 9
44	4010G15311	SHADE R	GPS	1	
45		DRYER AS		1	REFER TO # 9
46		ASSY URT *T DOOR		1	REFER TO # 11
47	4010G46014	LINER F DR	ABS 1.4 x 785 x 1200	1	
48	4010G30090	POCKET F *T	GPS	2	
49	4010G47104	GASKET F DR	PVC-S 42	1	
50	401SA45302	HNDL F (B) AS		1	
51	4010G45066	PANEL F CONTL	ABS	1	
52	3014300600	PCB *F AS		1	
53	4010G70311	KNOB TIMER CONTL	ABS	1	
54	4010G45086	LABEL C/B	PC FILM	1	
55	4010G51402	HINGE *T AS	SPHC	1	
56	3016000301	SPECIAL SCREW	M5 x 14 S1018C ZN5MICRO	3	
57	4010G51455	COVER *T HI	PP 42	1	
58	4010G74202	LOUVER F INSU AS		1	
59	4017Z29010	BRACKET F SENS	SPCC	1	
60	4010G74012	LOUVER F	HIPS 41C	1	
61		ASSY URT *U DOOR		1	REFER TO # 11
62	4010G37017	LINER R DR	ABS 1.4 x 785 1105	1	
63	4010G47204	GASKET R DR AS		1	
64	3012900401	HINGE *U AS	MF-ZN5-C	1	
65	3016000600	SPECIAL SCREW	M6 x 20	4	
66	30100A0271	COVER V/CASE AS		1	
67	4010G30621	CASE EGG	GPS	2	
68	4010G30611	POCKET EGG	HIPS	2	
69	4010G30640	POCKET BOTL	HIPS	2	
70	3011108900	CASE CHILD	GPS	1	
71	3011715600	DOOR CHILD	GPS	1	
72	4010E99102	BOX ICE AS		1	
73	3011424100	CASE VEGETB	GPS	1	
74	4010G55120	SHELF R	GP	2	
75	4010G30661	BOILD	PP T1.3	1	
76	4010G65015	COVER CAB BRKT	PP	1	
77	3011100400	CASE ICING AS		1	
78	3017808200	SHELF F	GPS (INSAE=MU)	1	
79	4010G00018	GRILLE	PP(B-391G YUKONG)	1	
80	4010E59900	DEODORANT		1	OPTION

11. ELECTRONIC FUNCTION

1. FR-490P

1) How to use the panel

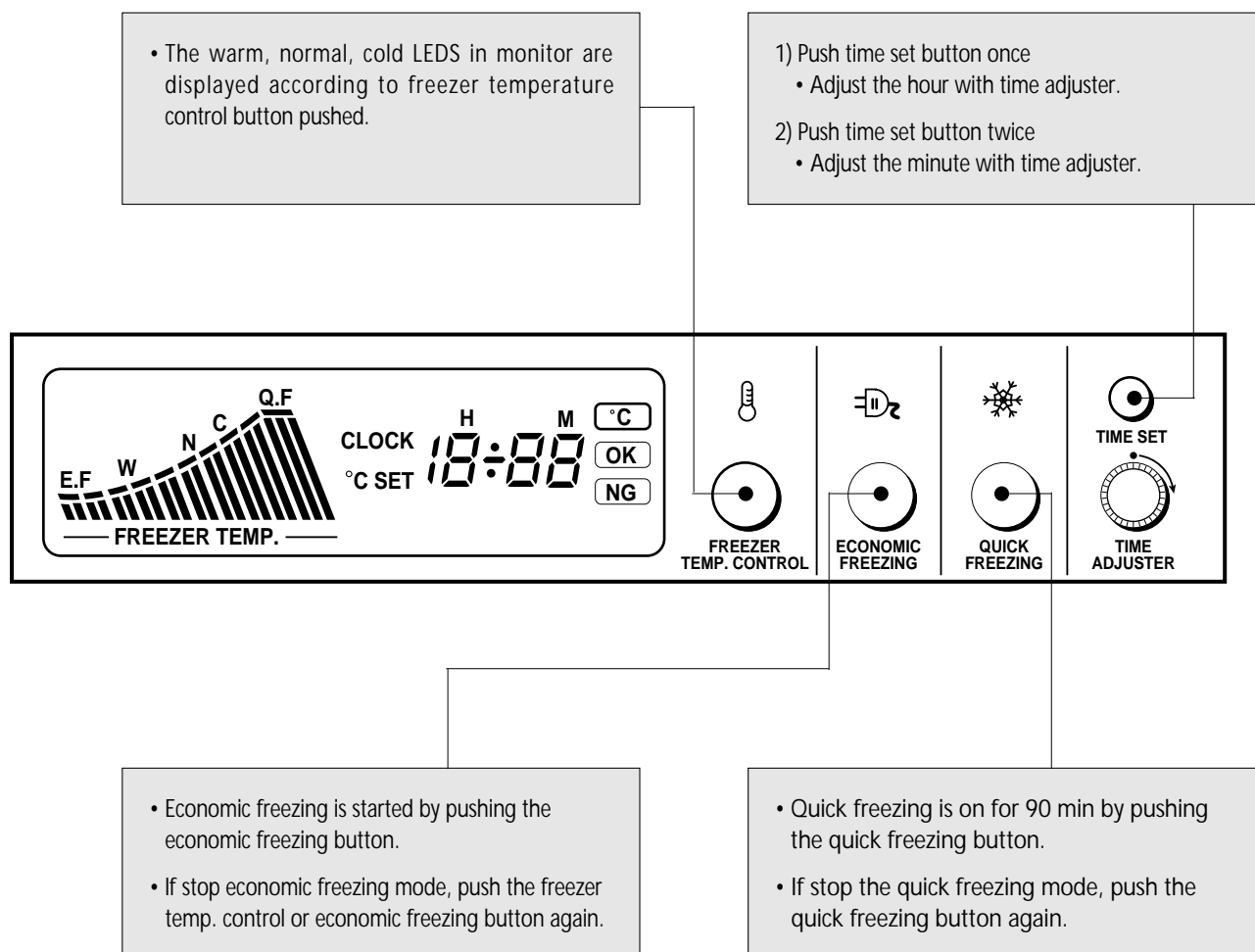

2) Function table

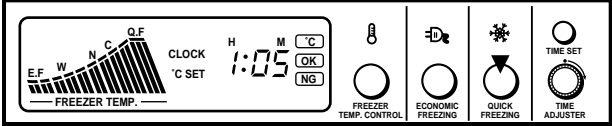
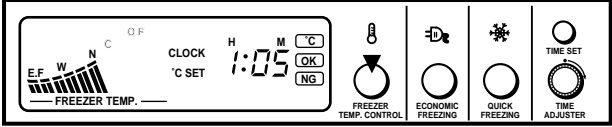
NO.	Control Function	Control Objects	Contents	Remark												
1	Quick Freezing	COMP. Fan LED	<p>1. Quick freezing is started by pushing the quick freezing button.</p> <p>2. If stop the quick freezing mode, push the quick freezing button again.</p>  <p>3. The quick freezing mode works for 90 min.</p> <p>4. When the quick freezing mode is over or manually reset, the refrigerator will return to a former function automatically.</p> <p>5. If quick freezing switch is turn on during defrosting Pre-cool, defrosting starts from Pre-cool after finishing quick freezing. But if COMP. has been operating for more than 40 min., the Pre-cool will be omitted.</p> <p>6. If quick freezing switch is turned on during Defrosting Heater on or Fan delay, it performs quick freezing just after finishing defrosting.</p>													
2	Freezer temperature control	COMP. Fan	<p>1. When the power of refrigerator is on, the normal temperature is automatically set.</p> <p>2. It is adjusted 3 steps by freezer temperature button.</p> <p>3. The WARM, NORMAL, COLD LEDs in monitor are displayed according to freezer temperature control button pushed.</p>  <p>4. In 5 seconds, after pushing, the monitor display the current time.</p> <p>5. The F-sensor temperature is as followed according to COMP. on/off time.</p> <table border="1" data-bbox="608 1648 1278 1760"> <thead> <tr> <th></th> <th>Cold</th> <th>Normal</th> <th>Warm</th> </tr> </thead> <tbody> <tr> <td>COMP. off</td> <td>-27°C</td> <td>-24°C</td> <td>-21°C</td> </tr> <tr> <td>COMP. on</td> <td>-12°C</td> <td>-18°C</td> <td>-15°C</td> </tr> </tbody> </table>		Cold	Normal	Warm	COMP. off	-27°C	-24°C	-21°C	COMP. on	-12°C	-18°C	-15°C	
	Cold	Normal	Warm													
COMP. off	-27°C	-24°C	-21°C													
COMP. on	-12°C	-18°C	-15°C													
3	Prevent COMP. restarting	COMP. Fan	<p>1. When the compressor is stopped, it cannot restart within 6 min.</p>													
4	Refrigerator temperature control	Damper Fan	<p>1. It can be controlled by open/close of baffle plate in damper according to temperature change of the refrigerator.</p>													

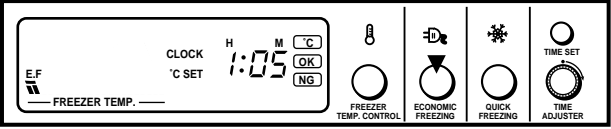
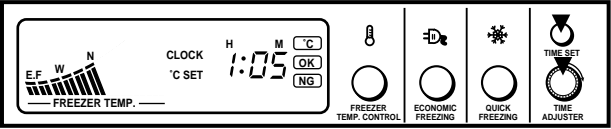
NO.	Control Function	Control Objects	Contents	Remark
			<ol style="list-style-type: none"> When the knob of the damper is located at off position, the temperature of refrigerator is the same as ambient temperature. When the knob of damper is located at normal position, the temperature of refrigerator is 3~4°C. 	
5	Economic freezing	COMP. Fan Monitor	<ol style="list-style-type: none"> Economic freezing is started by pushing the economic freezing button.  <ol style="list-style-type: none"> If stop economic freezing mode, push the freezer temperature control button or economic freezing button again. 	
6	Clock set	Monitor	<ol style="list-style-type: none"> When the power of the refrigerator is on, the the clock is set at 12:00.  <ol style="list-style-type: none"> When push the time set button, the 12(hour) will blink, then set hour with the time adjuster. It can be set from 0 to 12. When you push the time set button again, the 00(min.) will blink, then set min. by turning the time adjuster. It can be set from 00 to 59. 	
7	Defrost mode	COMP. Fan Heater LED	<ol style="list-style-type: none"> When the accumulating time of the COMP. operation is 8 hours, the defrost mode is started. If the D-sensor senses below 0°C at initial power on, then the defrost mode is started. The compressor must continuously run for 32 min. at Pre-cool regardless of freezer temperature setting. In D-heater on, if D-sensor's temperature is 13°C, D-heater is off. COMP. & fan must be off at COMP. & fan delay step. Defrost LED on the M-PCB is on, during the defrost mode. 	

NO.	Control Function	Control Objects	Contents	Remark																									
			<table border="1"> <thead> <tr> <th data-bbox="604 398 727 472"></th> <th data-bbox="727 398 866 472">Pre-cool</th> <th data-bbox="866 398 1003 472">Defrost heater</th> <th data-bbox="1003 398 1141 472">COMP & fan delay</th> <th data-bbox="1141 398 1278 472">Common mode</th> </tr> </thead> <tbody> <tr> <td data-bbox="604 472 727 546">COMP. & fan</td> <td data-bbox="727 472 866 546">████████</td> <td data-bbox="866 472 1003 546"></td> <td data-bbox="1003 472 1141 546"></td> <td data-bbox="1141 472 1278 546">████████</td> </tr> <tr> <td data-bbox="604 546 727 620">D-heater</td> <td data-bbox="727 546 866 620"></td> <td data-bbox="866 546 1003 620">████████</td> <td data-bbox="1003 546 1141 620"></td> <td data-bbox="1141 546 1278 620"></td> </tr> <tr> <td data-bbox="604 620 727 694">D-LED</td> <td colspan="3" data-bbox="727 620 1141 694">████████████████████</td> <td data-bbox="1141 620 1278 694"></td> </tr> <tr> <td data-bbox="604 694 727 719">Prior</td> <td data-bbox="727 694 866 719">Function</td> <td colspan="2" data-bbox="866 694 1141 719">Defrost</td> <td data-bbox="1141 694 1278 719">Function</td> </tr> </tbody> </table>		Pre-cool	Defrost heater	COMP & fan delay	Common mode	COMP. & fan	████████			████████	D-heater		████████			D-LED	████████████████████				Prior	Function	Defrost		Function	
	Pre-cool	Defrost heater	COMP & fan delay	Common mode																									
COMP. & fan	████████			████████																									
D-heater		████████																											
D-LED	████████████████████																												
Prior	Function	Defrost		Function																									
8	Forced defrost	D-heater	<ol style="list-style-type: none"> 1. If quick freezing button is pushed 5 times and freezer temperature control button is pushed at the same time, then forced defrost mode begins. 2. Its procedures are from D-heater to COMP. & fan delay except Pre-cool step. 3. The others are same as defrost mode. 																										
9	Judgement of sensor defect	NG LED Monitor	<ol style="list-style-type: none"> 1. The refrigerator can check of the sensors, such as open, short and the defect of disconnections. 2. The checktime of the sensor defect is after initial power on, before the defrost mode. 3. When the sensor defect is checked, the NG LED is on, and the error message is displayed according to the kinds of defects. 4. When the sensor defect occurs, all functions are stopped. 																										

3) Self-diagnosis table

Error mode	Defect function	Check method
F 1	Open F-sensor	<ul style="list-style-type: none"> - The voltage of port 3 in micom is lower than 0.2V or not. - The connection state of connector(C3) in M-PCB is good or not. - The characteristics of diode D02, D04 are good or not. - The resistance value of R6 is the same as standard value or not.
F 2	Short F-sensor	<ul style="list-style-type: none"> - The voltage of port 3 in micom is lower than 0.2V or not. - The connection state of connector(C3) in M-PCB is good or not. - The characteristics of diode D02, D04 are good or not. - The resistance value of R6 is the same as standard value or not.
E 1	Open D-sensor	<ul style="list-style-type: none"> - The voltage of port 4 in micom is lower than 0.2V or not. - The connection state of connector(C3) in M-PCB is good or not. - The characteristics of diode D03, D05 are good or not.
E 2	Short D-sensor	<ul style="list-style-type: none"> - The voltage of port 4 in micom is lower than 0.2V or not. - The connection state of connector(C3) in M-PCB is good or not. - The characteristics of diode D03, D05 are good or not.
F 3	Defect defrost	<ul style="list-style-type: none"> - D-sensor is good or not. - The applied voltage in D-sensor is higher than 2.94V or not. - The resistance value of R5 is the same as standard value or not. - Defrost heater is good or not. (Resistance of heater is 327 ; 260Ω.) - The thermal fuse is good or not. - The relay(RY3) for defrost is good or not.
F 4	Defect switch	<ul style="list-style-type: none"> - The port 26, 27, 28, 29 and 30 in micom are high level or not. - Each switch(button) is good or not.
F 5	Defect compressor Gas leakage Defect freezing cycle Defect F-sensor	<ul style="list-style-type: none"> - F-sensor is good or not. - The resistance value of R021, R022 in F-PCB is good or not. - The compressor is good or not. - The gas in freezing cycle is leaked or not.

◆ After repairing, must initialize micro-processor, if not, then the error message in monitor is not erased. The method for initialization is to short the terminal of capacitor CO10.

4) Circuit and wiring diagram

D I D D I D E D	SYMBOL	VOLTAGE
		5.0V
		5.4V
		7.2V
		12.0V
	12.8V	
	14V	

